

LORS / TECNA[®]

1090 LOUSONS ROAD ♦ UNION, NEW JERSEY 07083 USA
Tel: 908-964-9100 ♦ Fax: 908-964-4492 ♦ email: sales@lors.com

WELDING CONTROL UNIT: TE 300 USER MANUAL

RELEASE SOFTWARE No. 01

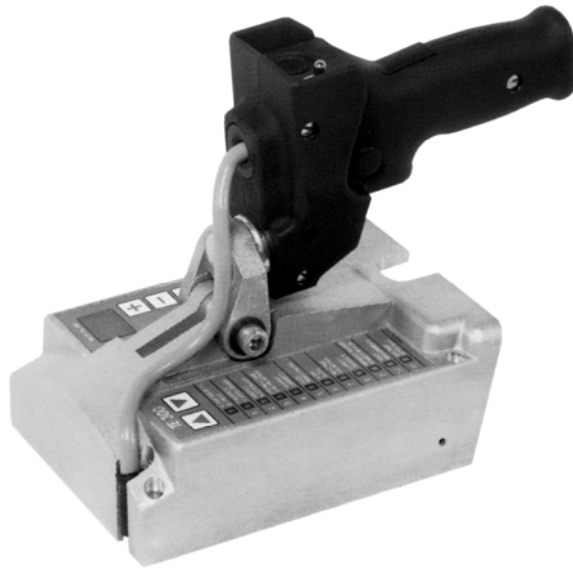

DOCUMENT NUMBER: MAN 4082
EDITION: JANUARY 1998

TABLE OF CONTENTS

SUBJECTS	PAGE
WELDING CONTROL UNIT TE300	3
MAIN TECHNICAL DATA	3
PROGRAMMING THE CONTROL UNIT	4
DESCRIPTION OF THE WORKING CYCLE	5
DESCRIPTION OF THE PARAMETERS	6
EXAMPLES OF WELDING PROGRAMS	7
DOUBLE STROKE FUNCTION	9
USE OF THE "PRESSURE ONLY" CONTROL	10
"CHK" INPUT FUNCTION	11
THERMOSTAT INPUT FUNCTION	11
DELAY FUNCTION OF FIRST PHASE SHIFT	11
COMPENSATION OF THE SECONDARY CURRENT	12
FUNCTION OF ADJUSTMENT TO WELD $\cos \varphi$	12
LAMPS ON THE CONTROL UNIT	13
ERROR LIST	14
SIGNAL DESCRIPTION ON CONNECTORS	15

WELDING CONTROL UNIT TE 300

The welding control unit is used to control the welder parts and, in particular, the thyristor adjusting the welding current. TE300 is a microprocessor welding control unit for suspended resistance welding guns. This control unit includes specific functions to be used when working with suspended welding guns, such as the double stroke control, and a function checking the efficacy of the safety devices which can be eventually installed on the handle of the machine. It is possible to program 2 different welding programs which can be recalled by an external device. Each program is formed by 11 programmable parameters which describe the working cycle. Besides the simple 4 times cycle, the control unit enables to carry out welding processes with pre-weld current, slope and pulses. Another available function of this control unit is the compensation of the minimum current.

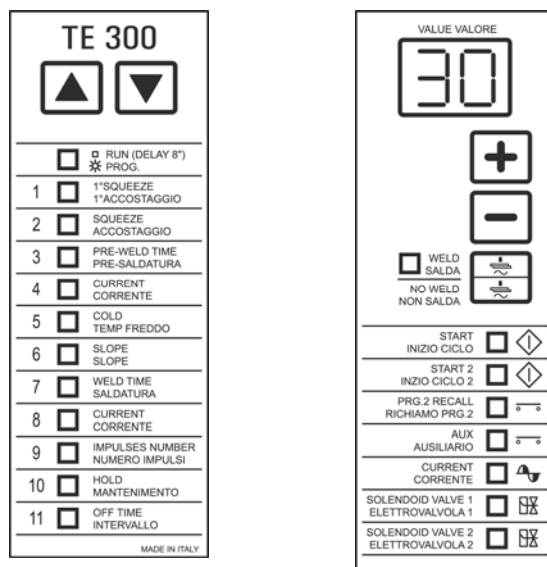



MAIN TECHNICAL DATA



- Simplified programming by means of 5 push-buttons.
- Synchronous thyristors drive with phase shift control for welding current adjustment.
- 2 welding programs to be stored up and selectable by an external device.
- 11 programmable parameters for each program.
- Slope and pulse functions.
- Single and automatic cycle.
- Automatic double stroke.
- Compensation of the secondary current to weld oxidized sheets and rods.
- WELD/NO WELD function.
- Delay of first phase shift adjustment to get the best balance of the machine absorption from mains.
- Control of 2 solenoid valves 24 Vac 7.2 W Max with protected output against short circuit: electrode closing valve and double stroke valve.
- Self-adjustment to the mains frequency 50/60 Hz.



PROGRAMMING THE CONTROL UNIT

When the control unit is activated, the display shows the version of the program. After a few seconds, the TE 300 is set in a waiting condition enabling the operator to carry out the welding process. To program the control unit, adjust the parameters describing the welding cycle; select the parameters and set them to the required values one by one. To better understand the meaning of each parameter, please look it up on the relevant paragraph.

To start the programming, press push-buttons  and  simultaneously for at least one second: the led PROG. lights on, thus enabling the programming. After an 8 seconds inactivity, the control unit will automatically end the programming operations, thus enabling the working.

The working program which is displayed, and which can thus be modified, is the one which is used at the moment, that is to say the one which can be recalled by an external device (as a rule, a two-position selector placed on the handle).

The parameters are marked with numbers from 1 to 11, and are listed on the left side of the control unit. A led is connected to each parameter. Select the parameters by means of buttons  and , the pilot line corresponding to the selected parameter lights on and its value is shown on the display.

Change the welding parameters value by means of buttons  and  by increasing or decreasing the value shown on the display. The parameters values can vary according to the type of parameter, the minimum and maximum values of each parameter are described in the following table.

PARAMETER NUMBER	PARAMETER	RANGE VALUE
1	1° SQUEEZE	00 - 99 cycles
2	SQUEEZE	01 - 99 cycles
3	PRE-WELD TIME	00 - 60 cycles
4	PRE-WELD CURRENT	01 - 99%
5	COLD TIME	00 - 50 cycles
6	SLOPE	00 - 29 cycles
7	WELDING TIME	01 - 60 cycles
8	WELDING CURRENT	01 - 99%
9	IMPULSE NUMBER	01 - 09
10	HOLD	01 - 99 cycles
11	OFF TIME	00 - 99 cycles

Nevertheless, the above-illustrated table is subject to some exceptions:

- If OFF TIME (11) is set to 0, the control unit will work in single cycle.
- If OFF TIME (11) is set to 99, the control unit will enable the minimum current compensation function (see the paragraph "Compensation of the secondary current").
- By setting parameter PRE-WELD TIME (3) to 0, the pre-weld will not be carried out.
- The value set in parameter 1° SQUEEZE (1) modifies the double stroke functioning (see the relevant paragraph).

In this way all the parameters used to carry out the welding process are set to the desired value. When this programming step is over, it is possible to use the welder without confirming the set or stored data.

Once this programming step is over, wait for the control unit to automatically end the programming operations; this will automatically take place after an 8 seconds inactivity. If the start device is activated before this time interval elapses, it will not be considered.

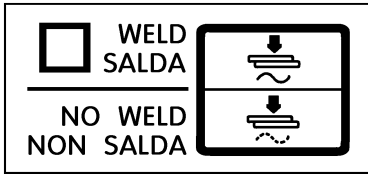

Use the WELD / NO WELD function to carry out any test cycle without welding current. By means of the here shown proper key, it is possible to either enable or disable the welding current. When the light is on, the control unit is set to WELD, and it carries out standard welding cycles. When the light is off, the control unit is set to NO WELD, and the control unit carries out complete test cycles without welding current, even though all the time-relevant parameters are preserved.

During the welding cycle the control unit will display the function being carried out, as well as its value.

When set on a waiting time condition, the control unit will display the number of the selected program, P1 for program number 1 and P2 for program number 2.

DESCRIPTION OF THE WORKING CYCLE

The TE300 working cycle is described by the user by adjusting 11 programming parameters. These parameters indicate the operating times and the current adjustments characterizing the working cycles whenever carried out consecutively. The following chart shows the execution order of the programmed functions.

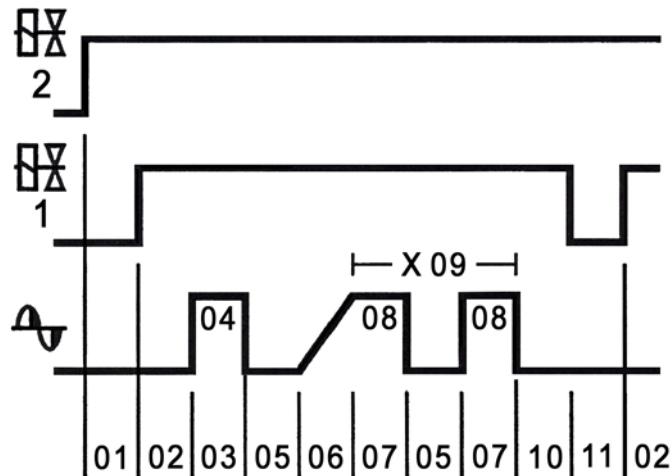

The numbers refer to the programming parameters which are described in the following paragraph.

Due to safety reasons, the microprocessor does not start the welding cycle if the cycle start signal is enabled when the welder is switched on; in this case, disconnect the control and then enable it again.

Any microinterruptions or excessive voltage drops block the control and do not alter the operation; to reset the operation, turn the machine off and then turn it on again.

DESCRIPTION OF THE PARAMETERS

All the following parameters indicating a period of time are expressed in periods, also called mains cycles. The mains frequency defines the duration of a cycle.

Mains frequency 50 Hz 1 period = 20 ms

Mains frequency 60 Hz 1 period = 16.6 ms

1 - 1°SQUEEZE

The 1° SQUEEZE time is used when working with automatic double stroke. It determines the electrode shifting time from the long stroke position to the short stroke one.

The set value must be long enough to have the mobile electrode reach the short stroke position.

Set the 1° SQUEEZE value to 0, to adjust the control for the fixed short stroke; set it to 99 to get the fixed long stroke (see the relevant paragraph).

During the first squeeze time, it is possible to end the cycle if the start cycle signal is disconnected.

This parameter can be set only if the welder and its handle foresee the control of the double stroke from the control unit.

2 - SQUEEZE

The SQUEEZE time determines the electrodes closing time, that is to say the time interval between the beginning of the electrodes closing and the starting of the welding process. The set value must be long enough to have the electrodes reach both the piece to weld and the proper clamping force before the starting of the welding process.

A too low adjustment of this time causes sparkles between electrodes and sheet when the welding process starts; it can also cause an irregular welding quality.

If the start cycle signal is deactivated during the squeeze time, the sequence is disconnected.

3 - PRE-WELD

The PRE-WELD parameter indicates the length of a passage which can be carried out before the welding process in order to pre-heat the piece to be welded. If this parameter is set to 0, the pre-weld will not be carried out. The pre-weld will be carried out at a current adjustment equal to that stated on parameter 4 (CURRENT).

4 - PRE-WELD CURRENT

The value expressed in this parameter indicates the power used to carry out the pre-weld.

5 - COLD TIME

The COLD 1 parameter, or cool time, is used during the pulses operation in order to indicate the time elapsing between a welding impulse and the following one. If the pre-weld is enabled (that is, when the PRE-WELD time is other than 0), this cool time is also used between the pre-weld and the weld.

6 - SLOPE

The SLOPE parameter describes the time during which the programmed value of welding power has been reached. The initial value of this slope always corresponds to the minimum power, while the final value corresponds to the value of power being programmed in parameter 8 (CURRENT). The slope speed is automatically calculated by the microprocessor according to the programmed values. The SLOPE time is summed to the welding time.

7 -WELDING TIME

The WELDING TIME parameter indicates the current flow duration. It will be carried out with the same power value stated on parameter 8 (CURRENT). When the pulse operation is on, this parameter signals the duration of each pulse.

8 - CURRENT

The value expressed in CURRENT indicates the welding operating power.

9 - IMPULSE N.

The IMPULSE N. parameter indicates the number of impulses used for the welding process. The duration of each impulse corresponds to the time set on parameter 7 (WELDING TIME).

10 - HOLD

The HOLD parameter describes the time elapsing between the end of the welding process and the opening of the electrodes. It enables a quicker cooling of the welding spot and avoids that is, it moved before a proper cooling.

11 - OFF TIME

The OFF parameter, or waiting time, indicates a machine waiting time elapsing between one machine cycle and the next one when the welder is working in automatic cycle. When this value is set to zero, the machine will go on working in single cycle; if it is set to another value, the machine will work in the automatic cycle. When the machine works in single cycle, the control unit will carry out a single cycle each time it receives a start cycle signal. When the machine works in automatic cycle, the welder goes on executing welding cycles until the start cycle signal is released.

By programming this parameter to 99 the welding current compensation function is activated (see the relevant paragraph).

EXAMPLES OF WELDING PROGRAMS

4 TIMES SIMPLE CYCLE WITH SHORT STROKE, SINGLE CYCLE

NUMBER	PARAMETER	VALUE
1	1° SQUEEZE	00 cycles
2	SQUEEZE	20 cycles
3	PRE-WELD	00 cycles
4	PRE-WELD CURRENT	01 %
5	COLD TIME	00 cycles
6	SLOPE	00 cycles
7	WELDING TIME	16 cycles
8	CURRENT	40%
9	IMPULSE N.	01
10	HOLD	09 cycles
11	OFF TIME	00 cycles

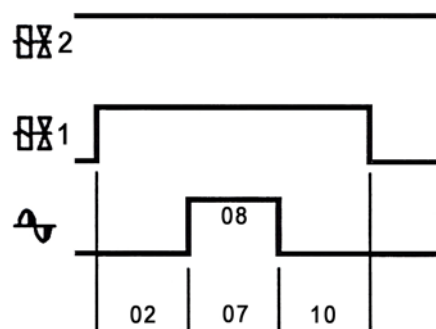

CYCLE WITH PULSES AND SLOPE, LONG STROKE, AUTOMATIC CYCLE

NUMBER	PARAMETER	VALUE
1	1° SQUEEZE	99 cycles
2	SQUEEZE	40 cycles
3	PRE-WELD	00 cycles
4	PRE-WELD CURRENT	01%
5	COLD TIME	07 cycles
6	SLOPE	06 cycles
7	WELD TIME	08 cycles
8	CURRENT	40%
9	IMPULSE N.	03
10	HOLD	09 cycles
11	OFF TIME	35 cycles

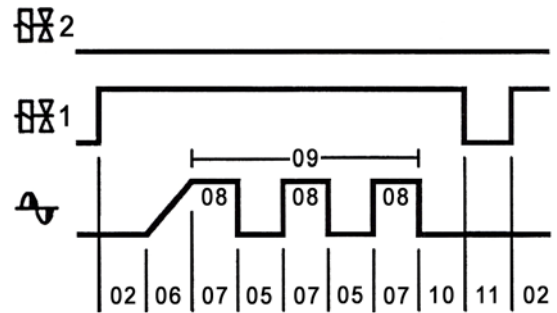

CYCLE WITH PRE-WELD, SLOPE, AUTOMATIC STROKE, AUTOMATIC CYCLE

NUMBER	PARAMETER	VALUE
1	1° SQUEEZE	20 cycles
2	SQUEEZE	30 cycles
3	PRE-WELD	08 cycles
4	PRE-WELD CURRENT	20%
5	COLD TIME	10 cycles
6	SLOPE	04 cycles
7	WELD TIME	12 cycles
8	CURRENT	60%
9	IMPULSE N.	01
10	HOLD	09 cycles
11	OFF TIME	40 cycles

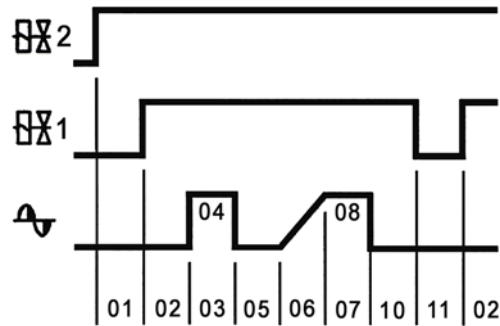

CYCLE WITH PRE-WELD, AUTOMATIC STROKE, AUTOMATIC CYCLES, NO COLD TIME BETWEEN PRE-WELD AND WELD

NUMBER	PARAMETER	VALUE
1	1° SQUEEZE	20 cycles
2	SQUEEZE	30 cycles
3	PRE-WELD	08 cycles
4	PRE-WELD CURRENT	20%
5	COLD TIME	00 cycles
6	SLOPE	00 cycles
7	WELD TIME	12 cycles
8	CURRENT	60%
9	IMPULSE N.	01
10	HOLD	09 cycles
11	OFF TIME	40 cycles

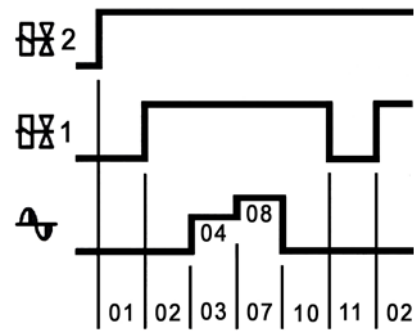

COMPLEX CYCLE WITH PRE-WELD, SLOPE, PULSES, AUTOMATIC STROKE, AUTOMATIC CYCLE

NUMBER	PARAMETER	VALUE
1	1° SQUEEZE	30 cycles
2	SQUEEZE	20 cycles
3	PRE-WELD	08 cycles
4	PRE-WELD CURRENT	20%
5	COLD TIME	10 cycles
6	SLOPE	04 cycles
7	WELD TIME	12 cycles
8	CURRENT	60%
9	IMPULSE N.	02
10	HOLD	09 cycles
11	OFF TIME	40 cycles

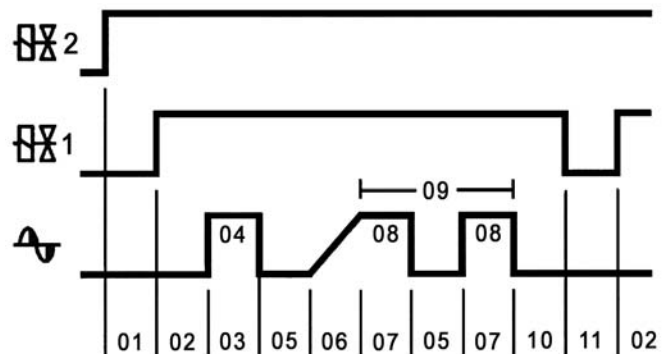

DOUBLE STROKE FUNCTION

The double stroke function is enabled only when the control unit is equipped with a handle enabling this function. This function is deactivated on all machines which are not designed for the double stroke control; as a consequence, it is not possible to set 1° SQUEEZE parameter.

The solenoid valve EV2 output drives the double stroke solenoid valve. When the machine is switched on, it is always deactivated even though the control unit is programmed for working with the short stroke. The OPEN input is connected to a push-button close to the operator, which is used to have the double stroke deactivated (electrodes opening).

The operator, by means of the 1° SQUEEZE parameter, selects one among the three possible working modes, here after explained.

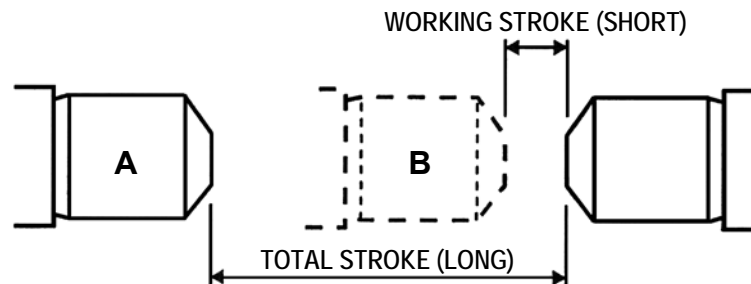

A - MOBILE ELECTRODE POSITION WITH DISCONNECTED DOUBLE STROKE (LONG STROKE)

B - MOBILE ELECTRODE POSITION WITH OPERATING DOUBLE STROKE (SHORT STROKE)

SHORT STROKE

By setting the 1° SQUEEZE parameter value to 0, the operator adjusts the control unit for the short stroke. Under this mode, the solenoid valve EV2 is kept activated, and the mobile electrode, under the rest condition, will be on "B" position.

If the operator needs to open the electrodes while working, he will press the "double stroke opening" push-button; it, by means of the OPEN input, disconnects the solenoid valve EV2. After having pressed the "double stroke opening" push-button, or when switching the welder on, the electrode is placed on "A" position; the control unit will move it to "B" position, when the first weld is carried out.

During the first weld, TE300 activates the solenoid valve EV2 (which shifts the electrode from "A" to "B" position), then it awaits for a 0.6 seconds fixed time and finally it carries out the programmed welding cycle. When the weld has been carried out, the solenoid valve EV2 is not deactivated and the electrode is kept on "B" position. The following welds will be carried out starting from this position.

It is possible to shift the electrodes from the long stroke position to the short one by means of the control "PRESSURE ONLY" (see paragraph "USE OF PRESSURE ONLY CONTROL").

Notice that each time the programming of the control unit starts, the double stroke solenoid valve EV2 is deactivated.

LONG STROKE

By setting the 1° SQUEEZE parameter value to 99, the operator adjusts the control unit for the long stroke. Under this mode, the solenoid valve EV2 is kept deactivated, and under the rest condition, the mobile electrode will be on "A" position.

In this case, the OPEN input activation has no effect. During the welding cycle, the 1° SQUEEZE time is not carried out.

AUTOMATIC STROKE

By setting the 1° SQUEEZE parameter to a value included between 1 and 99, the operator adjusts the control unit for the automatic stroke. This mode is used together with the automatic cycle functioning (parameter OFF# 0). It enables to carry out sequences of welding cycles with the short stroke, but starting from a long stroke working condition, that which, for instance, is useful for positioning the welding gun on the piece to weld.

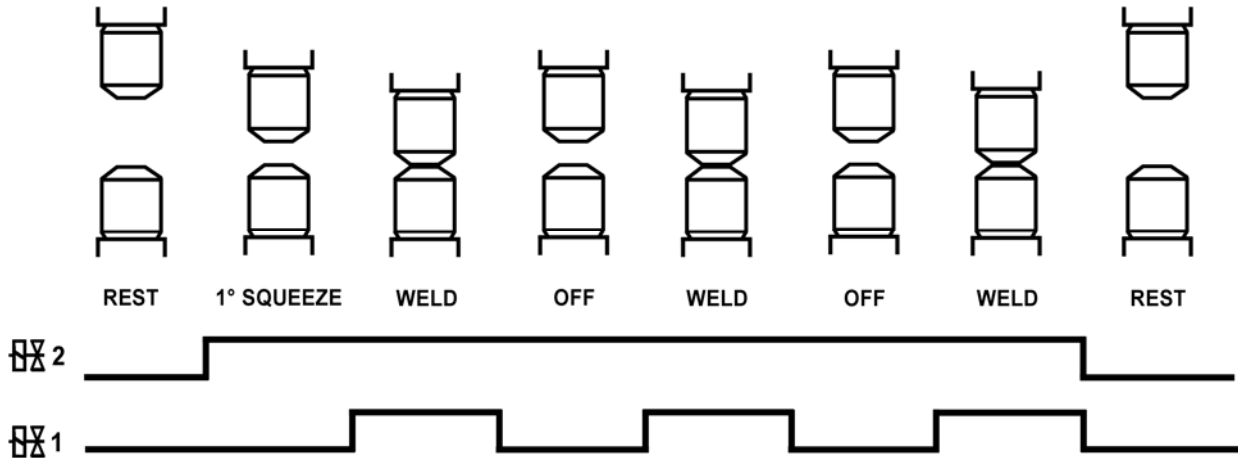

On START, the control unit activates the solenoid valve EV2 (which shifts the electrode from A to B position) and, before the activation of EV1, it carries out the programmed 1° SQUEEZE time. When the first weld of the automatic cycle is carried out, the EV2 is not disconnected and the 1° SQUEEZE is ignored for the following welds. This goes on until the operator does not release the start of cycle control device, thus ending the welds sequence, the control unit disconnects both EV1, and EV2, which returns the electrodes to the maximum opening. If the double stroke is activated before the starting of the welding process, the control will not carry out the 1° SQUEEZE time.

USE OF THE "PRESSURE ONLY" CONTROL

The "PRESSURE ONLY" control is usually used to check that the electrodes are correctly positioned before carrying out the welding process.

By activating the PRESSURE ONLY control (usually by pressing a push button placed on the welder handle) while the electrodes are closing, the welder clamps the pieces to weld and waits; the operator, after having checked the correct positioning of the electrodes, enables the cycle to continue by deactivating the control PRESSURE ONLY (releasing the push button). If the electrodes are not correctly positioned, the operator can cancel the operation by releasing the start of cycle device.

For welders with double stroke control only:

If the control unit has been set to "short stroke" mode (1° SQUEEZE = 0) the control PRESSURE ONLY device can be used to shift the electrodes from "long stroke" position to "short stroke" position, without closing the electrodes on the workpiece. This operation is sometimes necessary for particular welding conditions (i.e. works on thin thickness or requiring high precision).

The electrodes can be placed in a "long stroke" position either because they have been opened by means of the OPEN control, or because the welder has just been switched on.

When starting the welding cycle, TE300 brings the electrodes to "short stroke" position, thus activating the solenoid valve EV2, in 0.6 seconds. If the control PRESSURE ONLY is activated, the welding cycle stops in this position. By keeping this condition for one second and then deactivating the start of cycle control, the electrodes stay in the "short stroke" position.

If the PRESSURE ONLY control is released the cycle continues and the welding is accomplished.

"CHK" INPUT FUNCTION

On the handle of the suspended welding gun there can be installed a safety micro-switch carrying out a special function: it enables to start the cycle only if the operator has previously grasped the handle. As a rule, this micro-switch is placed in series to the start of cycle one. In order to get a better safety, the control unit, by means of the CHK input, checks that this input is activated when the welding process starts. If the signal is not activated, the TE300 does not accept the start of cycle signal; the following message will be displayed:

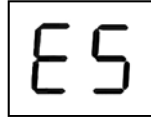

Moreover, the control unit checks that this micro-switch is neither broken (it keeps closed), nor tampered. This test is carried out:

- when switching the control unit on
- when pressing the double stroke opening push-button
- when shifting from RUN to PROGRAM

Under these conditions, the control unit displays the following error message, and it does not enable the welding process. The error does not block the machine functioning; the error will be automatically cleared, when its cause is removed.

THERMOSTAT INPUT FUNCTION

This input is connected to a normally closed thermostat which is placed on the welder. When starting the welding cycle, if the following error message is displayed:

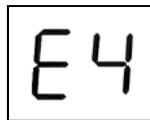

It is to mean that the thermostat got open. It is not possible to carry out welding processes until the thermostat is reset.

DELAY FUNCTION OF FIRST PHASE SHIFT

This function allows to obtain the best machine line current balance. To adjust it, set to CURRENT (8) parameter and simultaneously press push-buttons ▲ and ▼ for about one second to carry out the adjustment. The CURRENT (8) function lamp flashes and the display shows the new set value. As usual, the adjustment is carried out by pressing push-buttons + and -.

The value can be set from 35 up to 99. When the programming is over, press ▲ or ▼. As this adjustment is carried out by the welder manufacturer, the user does not need to modify this value.

COMPENSATION OF THE SECONDARY CURRENT

The compensation function of secondary current is used to facilitate the welding process of oxidized sheets and rods. The pieces oxidation blocks the current flow during the first welding phase, thus limiting, in a different way depending from the welding process, the real time of current flow. The compensation function controls the welding current by means of a coil located inside the secondary circuit. Until the welding current does not exceed a pre-set limit, the welding time is automatically extended up to a limit of 60 cycles. In this way it is possible to carry out welding processes with an always constant real time of current flow. If, after having reached the 60 welding periods limit, the current limit is not exceeded, the control unit will indicate that the welding process has not been correctly carried out by displaying the E3 error, and will block the welder functioning. To restore the functioning, press any push-button. The current limit is adjusted by the welder manufacturer by means of the welder manufacturer. The standard value is usually about 1500=2000 A. By means of JP1 jumper, located on the card, is possible to disable this function:

COMPENSATION	JUMPER JP1
ON	OPEN
OFF	CLOSED

This function is enabled by setting the parameter 11 (OFF TIME) value to 99; when this function is enabled, the control unit will work in single cycle.

FUNCTION OF ADJUSTMENT TO WELDER COS φ





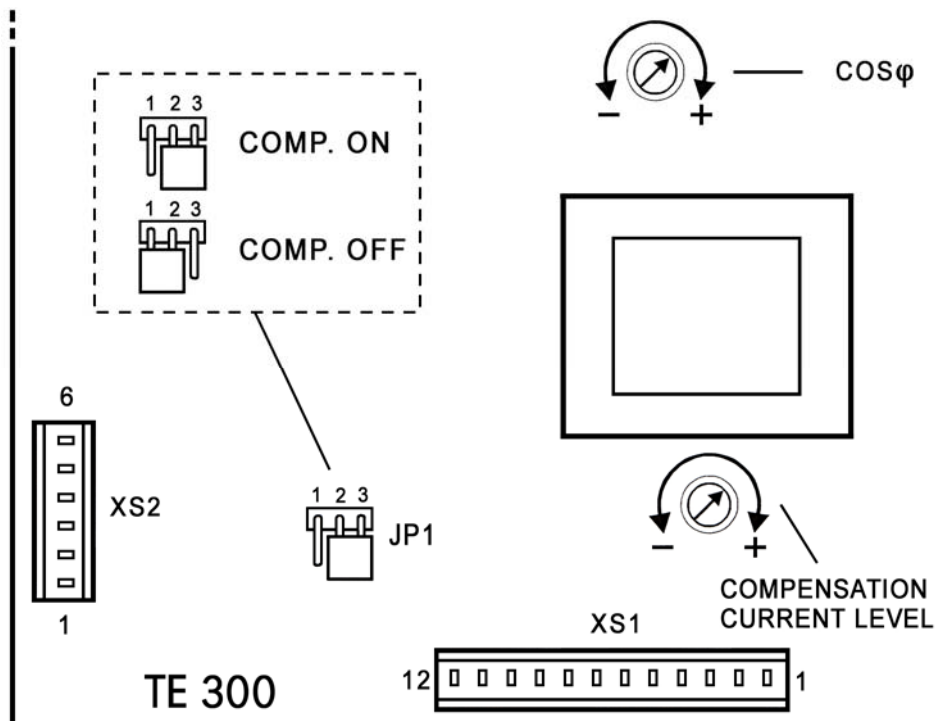

In resistance welders the phase displacement between the mains voltage and the absorbed current (i.e. $\cos \varphi$) changes according to the transformer characteristics, the dimensions of the secondary circuit and the material to be welded.

TE300 has an adjustment trimmer called "cos φ " enabling to suit the control to the $\cos \varphi$ of the welding machine on which it is installed.

This set up is made by the welder manufacturer, hence the user does not need to make any calibration.

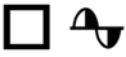

LAMPS ON THE CONTROL UNIT

<p>START INIZIO CICLO</p> 	<p>If on, it indicates that the start of cycle control triggered by the push-button placed on the handle is enabled.</p>
<p>PRG.2 RECALL RICHIAMO PRG.2</p> 	<p>It indicates that the external device recalling the welding program no. 2 is enabled.</p>
<p>AUX AUSILIARIO</p> 	<p>When this lamp switches on, it indicates that the stop-with-only-pressure device is enabled. This input is normally activated by the "PRESSURE ONLY" selector.</p>
<p>CURRENT CORRENTE</p> 	<p>When this lamp switches on, it indicates that the control unit is generating the SCR trigger impulses.</p>
<p>SOLENOID VALVE 1 ELETTROVALVOLA 1</p> 	<p>It indicates that the solenoid valve executing the main cycle is enabled.</p>
<p>SOLENOID VALVE 2 ELETTROVALVOLA 2</p> 	<p>It indicates that the solenoid valve driving the double stroke is enabled.</p>
 <p>RUN (DELAY 8") PROG.</p>	<p>When this lamp flashes, it indicated that the control unit is carrying out the programming. When this lamp is off, it indicates that the control unit is ready for carrying out welding cycles.</p>

ERRORS LIST

MESSAGE	CAUSE	REMEDY
E1	The value of one of the stored parameters exceeds the pre-set limits. This could be caused by a loss of data due to any interference or faulty functioning.	Press a push-button to clear the error. Check all the values being set in the parameters and correct them if necessary. Address to the after-sale service if the trouble reoccurs frequently.
E2	You are pulse operating and the total welding time (pre-weld time + welding time x impulse no.) is higher than 120 cycles. It is not possible to exceed this value in order to avoid the welder overheating.	Press a push-buttons to clear the error. Reduce either the welding time or the impulse number so to have a total welding time lower than 120 cycles.
E3	The compensation function is enabled and the control unit has extended the welding time up to the maximum limit corresponding to 60 periods. The set welding time has not been carried out with a welding current higher than the fixed limit.	Press a push button to clear the error. Before restart the welding process, check the welding conditions. If the pieces are too oxidized they must be cleaned.
E4	The built-in protection thermostat has been activated.	Check that the correct water quantity is running inside the welder and/or check the thermostat correct functioning.
E5	The CHK signal indicates that the safety device placed on the handle is working. This could be caused by either damage or tampering.	Check.

SIGNALS DESCRIPTION ON CONNECTORS

CONNECTOR XS1 (12 PINS)

NUMBER	NAME	MEANING
5-7	VAC	It is the control unit supply, which must be 24 Vac. The supply transformer must supply only the control unit in order to avoid possible troubles sources.
12	GND	Earthing. Connect to earth the output common line COM 2.
8 1	TRG + COM 2	Output for the trigger signal for the SCR. It is necessary to use the TECNA firing module for the SCR control.
4 3	ROG ROG	The current transducer (rogowski ring) must be connected to this analog input. The used transducer must have a 150 mV/kA sensitivity with a loading of 1 k Ω .
9 2	EV1 COM 2	Connect to the solenoid valve acting the cycle. Proper command for the 24Vac coil pilot system max 7.2 W coil.
11 10	TERM COM 1	This input has been designed for connecting a normally closed thermostat.
6 2	EV2 COM 2	Connect to the solenoid valve driving the double stroke. Proper command for the 24 Vac max 7.2 W coil.

REMARK: The outputs EV1, EV2, TRG+ are protected against short circuit thanks to electronic devices with automatic restart.

CONNECTOR XS2 (6 PINS)

NUMBER	NAME	MEANING
4 5	START COM 1	Connect to the start of cycle device microswitches. Both inputs are active closed on the common COM 1.
3 5	AUX COM 1	This input allows an external device to block the welding cycle during the squeeze phase. It is normally used for the "ONLY PRESSURE" function. The contact connected to this input must be of the normally open type.
2 5	RIC2 COM 1	This input enables the welding program No. 2 direct recall from outside. For a correct direct recall of the program, this input must be enabled before the start cycle signal. The input is working when closed towards common line COM 1.
6 5	OPEN COM 1	It is connected to the "OPEN" micro-switch, placed on the welder handle. It enables the double stroke opening. This input is working when closed towards common line COM 1. In the handles which are not equipped with this function, OPEN signal is always in short-circuit with the common COM 1. This indicates to the control that the double stroke function must not be carried out.
1 5	CHK COM 1	Input used to check the safety function eventually installed on the handle. This input is working when closed towards common line COM 1. If this function is not used because the handle is not equipped with this microswitch, short-circuit this input with the START one (pin 4). By this operation, the safety function against the accidental triggering is disabled.

HANDLE WIRING DIAGRAM FOR TE300-TE450 ON ITEM 330X

6 PIN - AMP MODU1 CONNECTOR

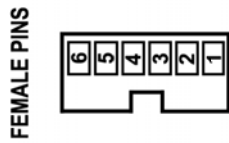
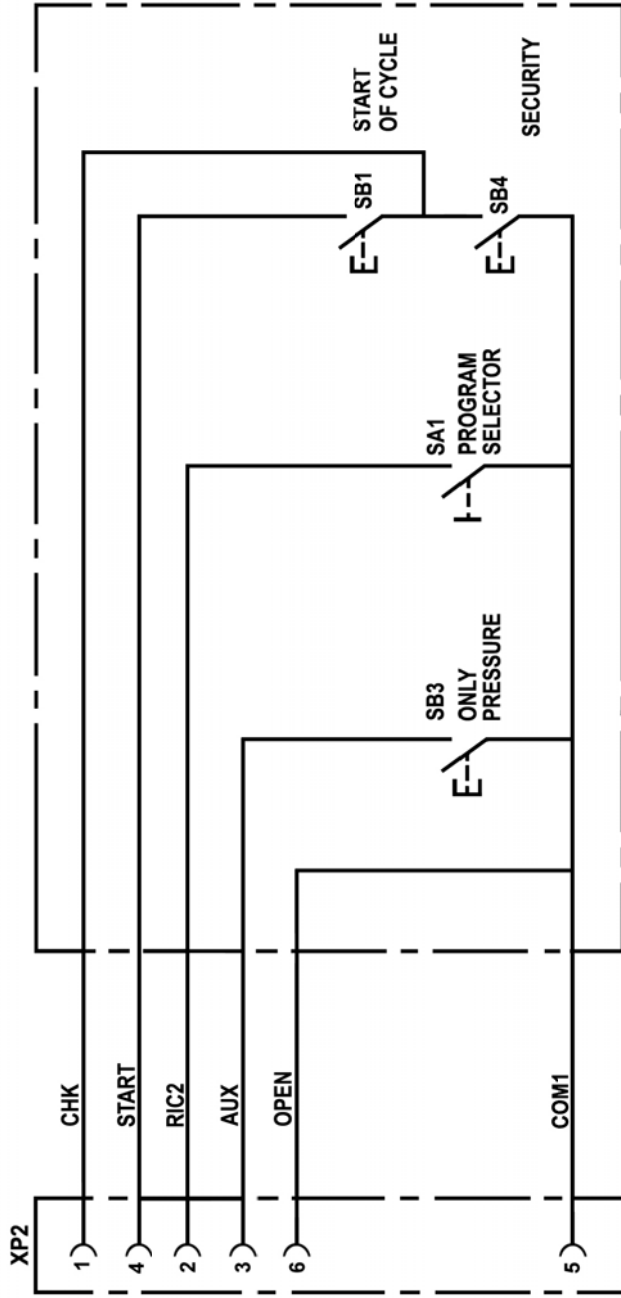

WIRE SIDE VIEW

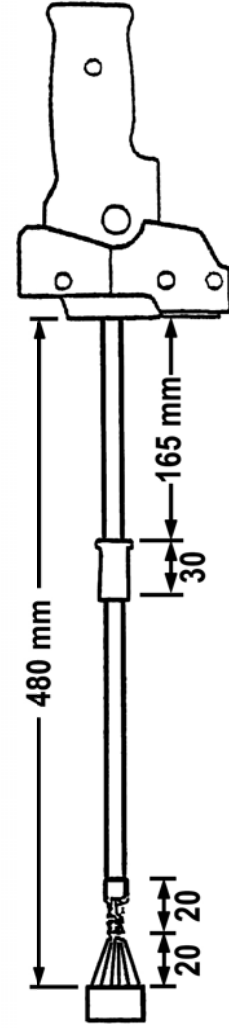
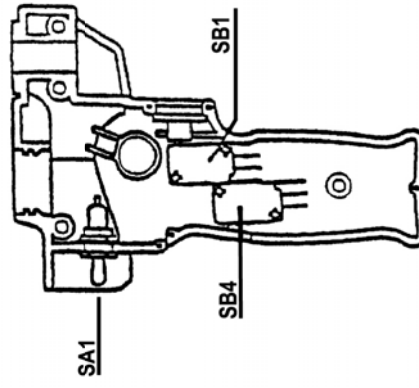
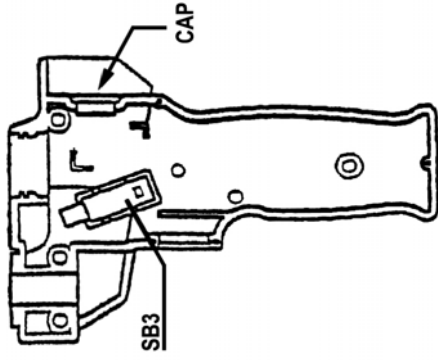

PROGRAM SELECTOR SWITCH - SA1
OPEN ON POSITION 1 - CLOSE ON POSITION 2

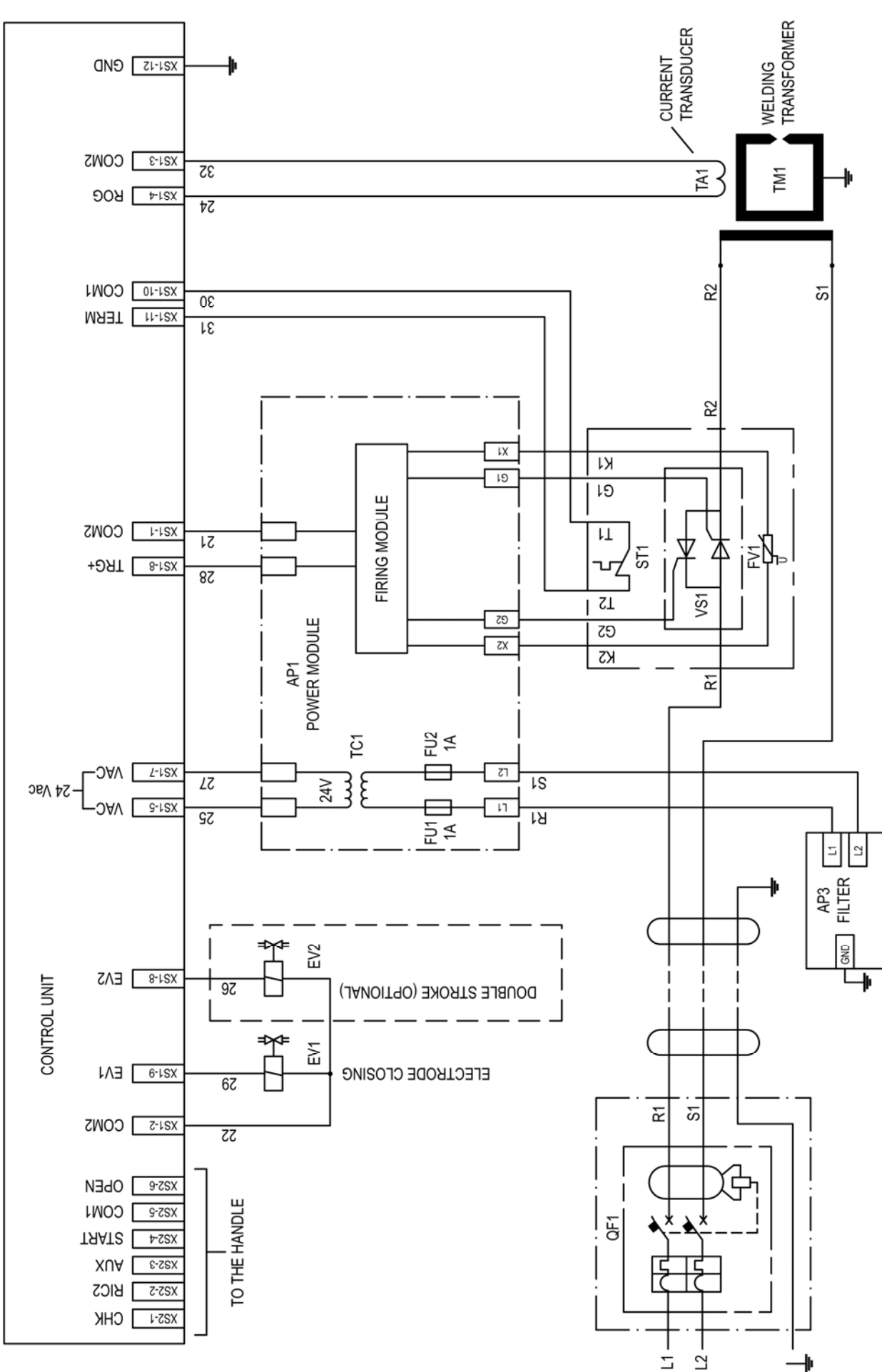

LORS MACHINERY, INC.
 1090 LOUSONS ROAD
 UNION, NJ 07083

**WIRING DIAGRAM FOR
 TE300/TE450**

